



# HIGH DESERT HARDWOOD

## Moulding Profiles

Warehouse: 1758 East State Street, Eagle, Idaho 83616 Phone: (208) 939-9366 FAX: (208) 939-9361

---

### RAIL (BAR)

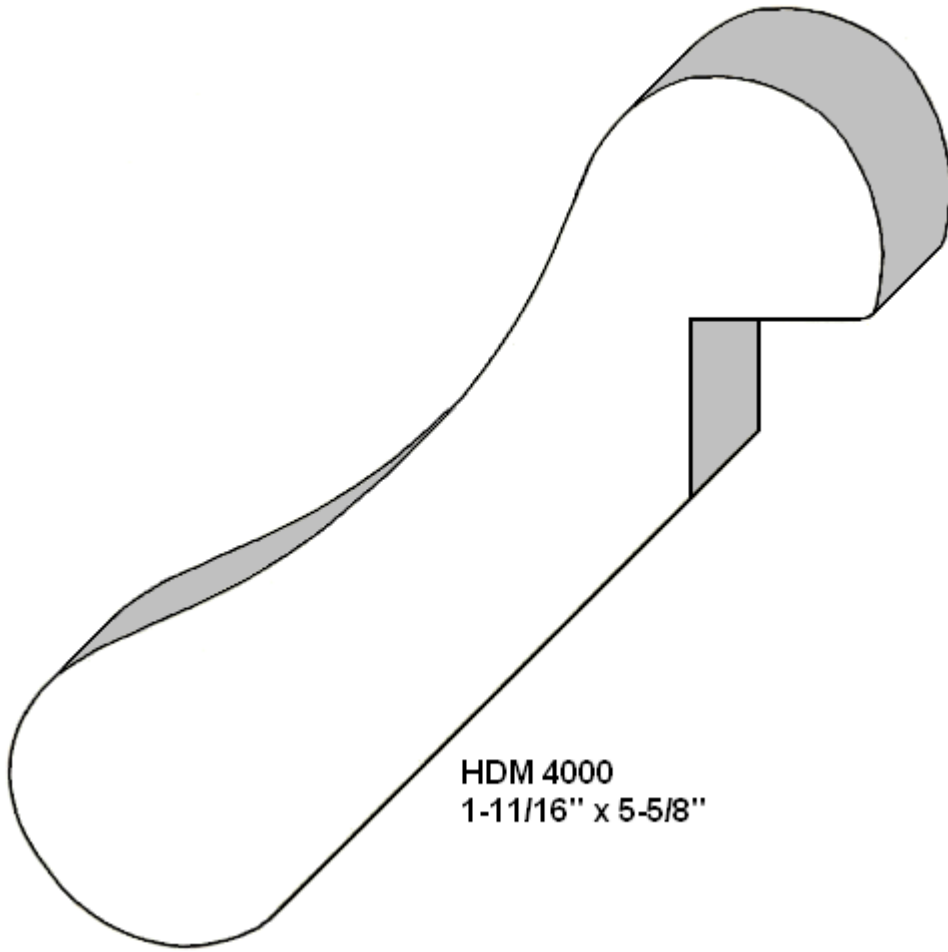

**HDM 4000**  
1-11/16" x 5-5/8"

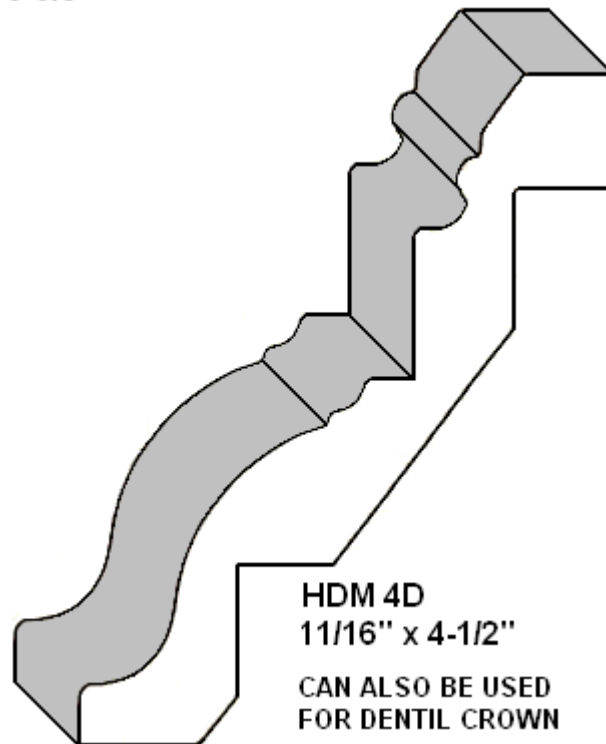

**HDM 4D**  
1 1/16" x 4-1/2"

**CAN ALSO BE USED  
FOR DENTIL CROWN**



# HIGH DESERT HARDWOOD

## Moulding Profiles

Warehouse: 1758 East State Street, Eagle, Idaho 83616 Phone: (208) 939-9366 FAX: (208) 939-9361

### RAIL (CHAIR)

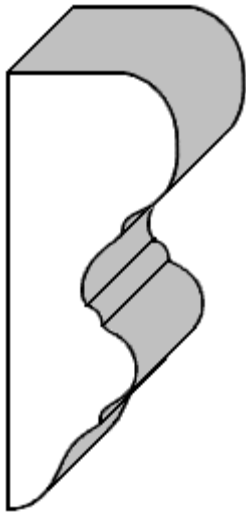

HDM 291  
7/8" x 2-5/16"

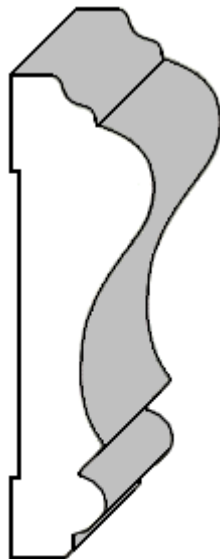

HDM 293  
3/4" x 2-1/2"

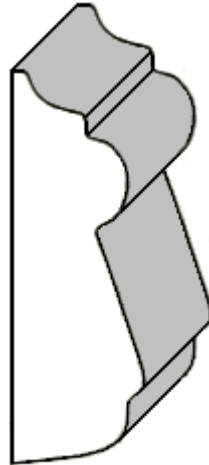

HDM 294  
11/16" x 2"

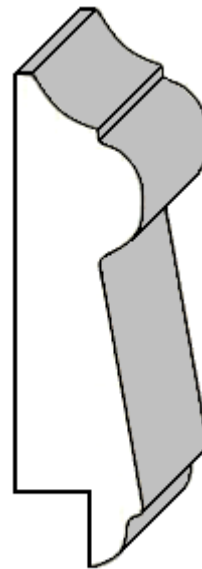

HDM 295  
11/16" x 2-5/8"

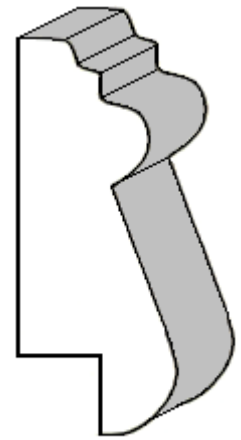

HDM 296  
3/4" x 2-1/16"



HDM 297  
3/4" x 2-1/4"



HDM 298  
11/16" x 2-1/2"

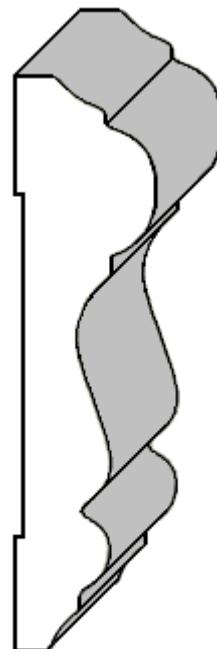

HDM 298-L  
13/16" x 3"

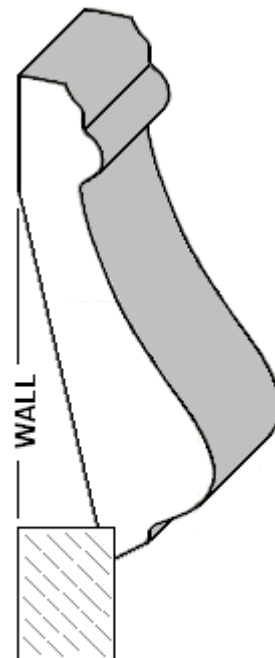

HDM 299  
11/16" x 2-1/2"  
Use with 1/2" panel



# HIGH DESERT HARDWOOD

## Moulding Profiles

Warehouse: 1758 East State Street, Eagle, Idaho 83616 Phone: (208) 939-9366 FAX: (208) 939-9361

---

### RAIL (CHAIR)

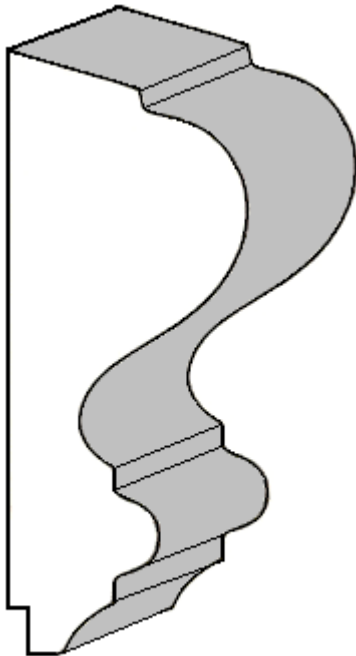

**HDM 305**  
1-1/4" x 3-1/8"

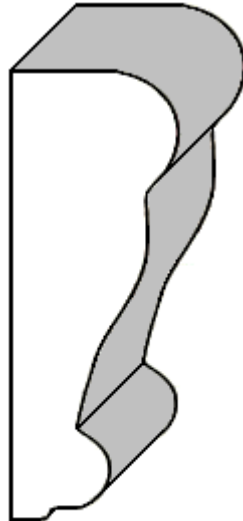

**HDM 308**  
13/16" x 2-3/8"  
(same as PF 238)

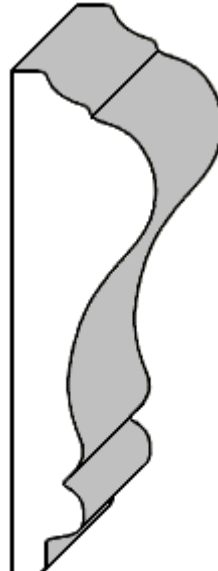

**HDM 309**  
11/16" x 2-1/2"

### RAIL (HAND)

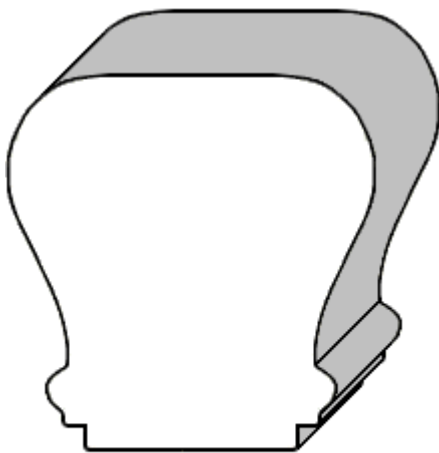

**HDM 1001**  
1-15/16" x 2"

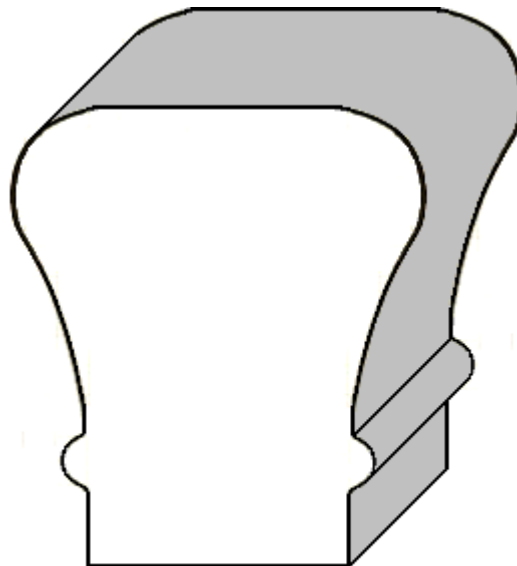

**HDM 1002**  
2-3/8" x 2-1/4"



# HIGH DESERT HARDWOOD

## Moulding Profiles

Warehouse: 1758 East State Street, Eagle, Idaho 83616 Phone: (208) 939-9366 FAX: (208) 939-9361

---

### RAIL (HAND)

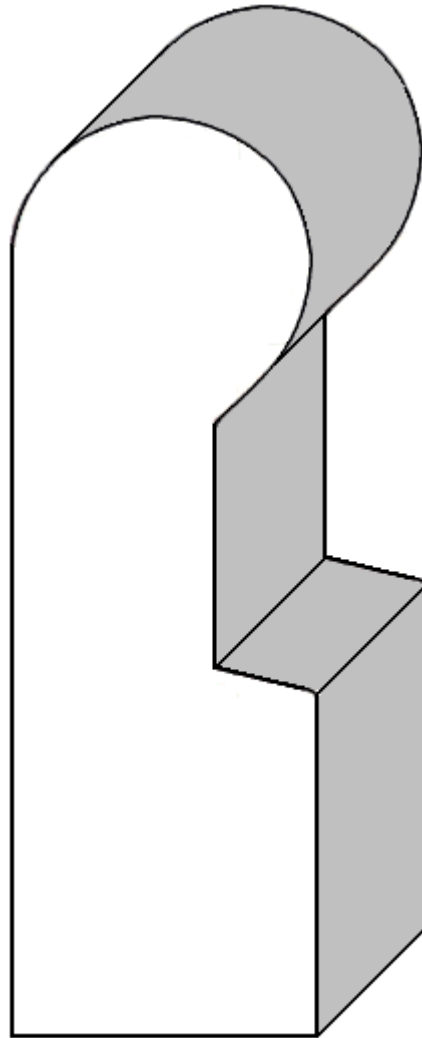

HDM 1005  
1-1/2" x O.E.

### RAIL (PICTURE)

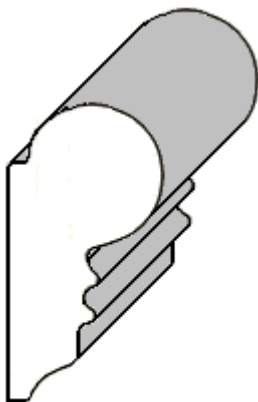

HDM 270  
3/4" x 1-5/8"

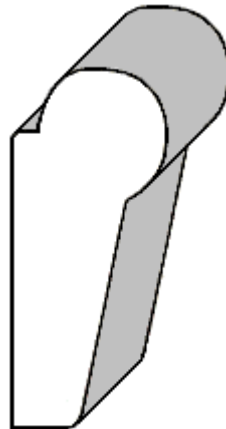

HDM 272  
3/4" x 1-7/8"

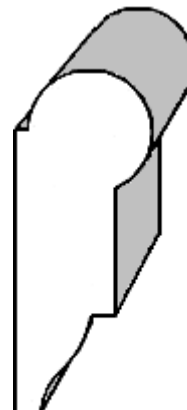

HDM 273  
11/16" x 1-3/4"



# HIGH DESERT HARDWOOD

## Moulding Profiles

Warehouse: 1758 East State Street, Eagle, Idaho 83616 Phone: (208) 939-9366 FAX: (208) 939-9361

### RAIL (TABLE)

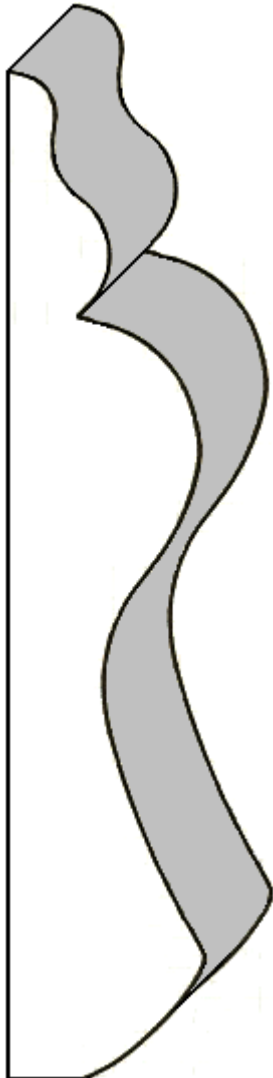

HDM 222  
1" x 5-1/4"

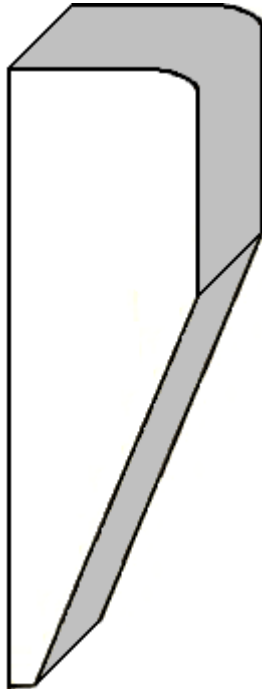

HDM 301  
1" x 3-1/4"

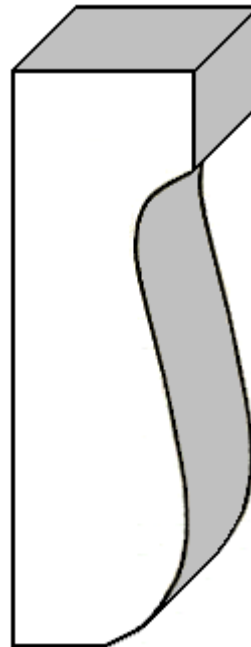

HDM 303  
15/16" x 3"

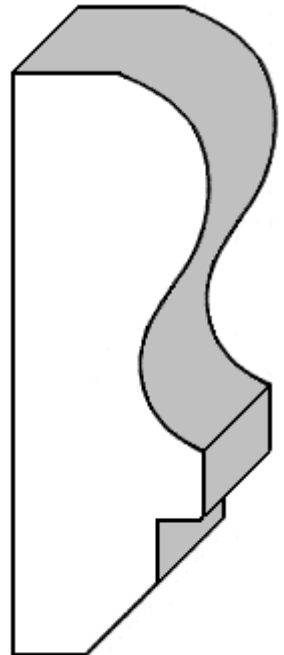

HDM 306  
1" x 3"

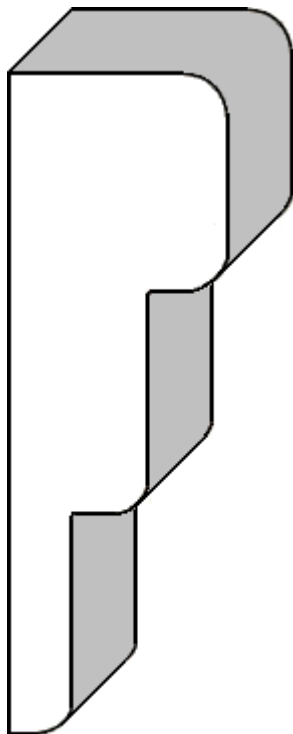

HDM 3415  
1-1/8" x 3-7/16"

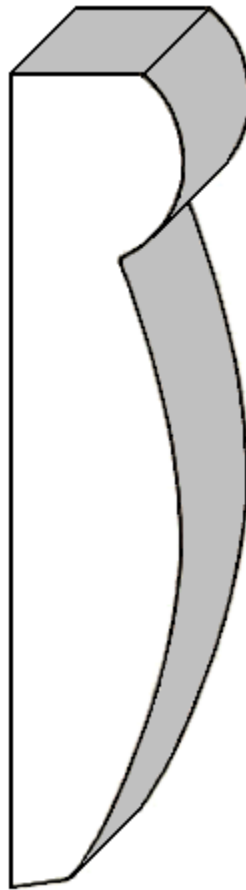

HDM 3416  
7/8" x 4-1/4"

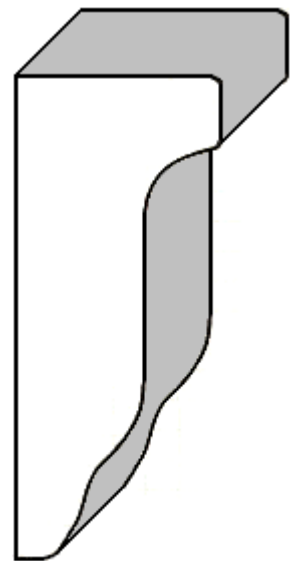

HDM TIN  
1-1/16" x 2-1/2"